

BJC



Iris Plus

Balance that inspires

No. 2



BJC

Iris Plus

Balance that inspires

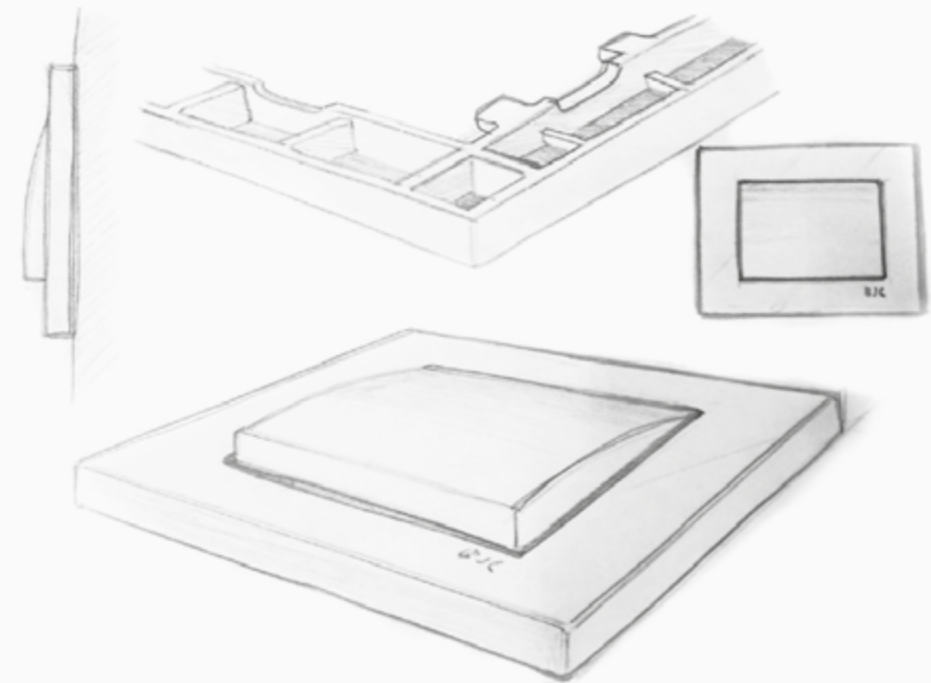

“ A combination of shapes that deliver an eclectic design.
A new linear frame that perfectly combines the curved
shape of the switch and the pleasant feel of the
mechanism in the Iris range.

Iris Plus

Style and elegance

We all see and interpret spaces differently. That's why we're introducing the new Iris Plus. This new option features a straight-line frame and now joins the hundreds of possibilities already offered by the standard IRIS series.



“ A very popular concept in the residential and tertiary sectors.



Cosso Anthracite



Mercury Aluminium



Chocolate





White



Iris Plus

Simple and clean design

 Made from an urea-based resin:
the unalterable white

 Flat surface

 Straight lines

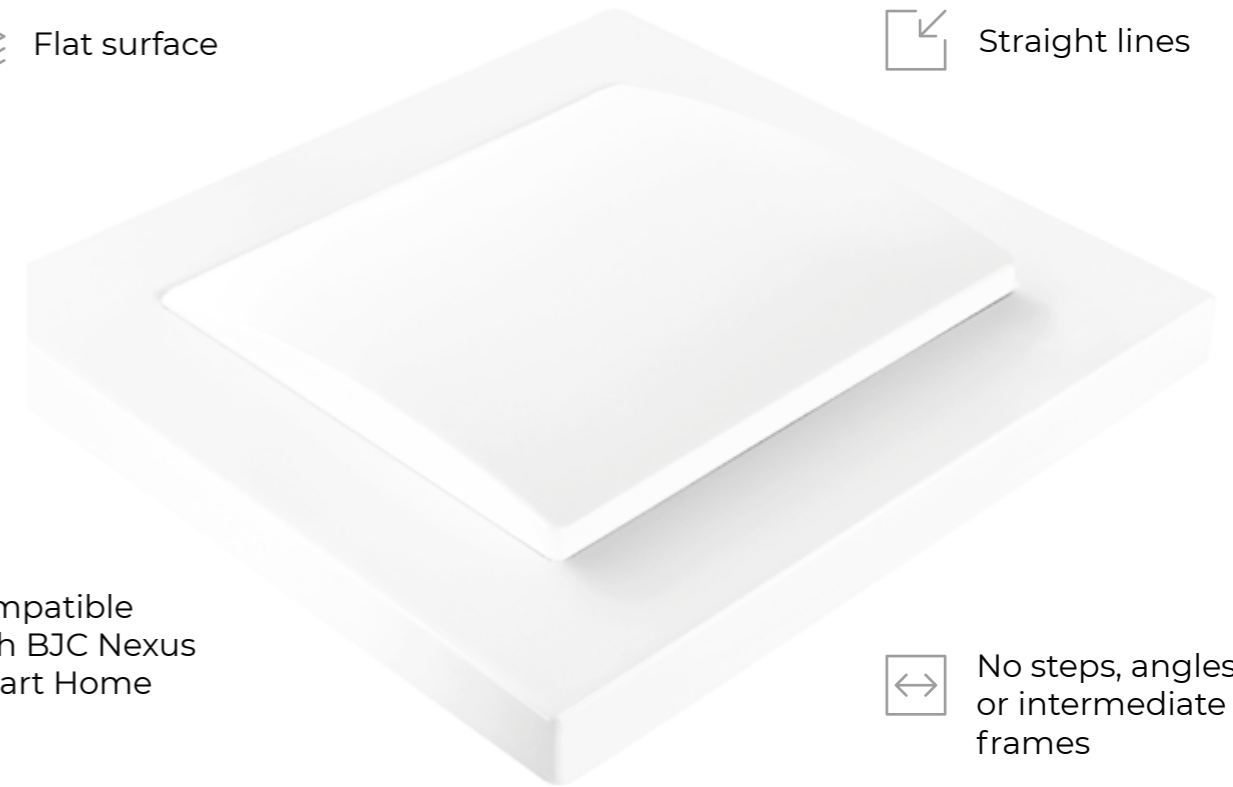

 Compatible
with BJC Nexus
Smart Home

 No steps, angles
or intermediate
frames

 Simple and
clean design

 Front view with
square lines

“ *The Iris and Iris Plus series are made from Urea, a thermosetting and self-extinguishing resin. Their thermosetting properties provide exceptional surface hardness, resistance to heat and fading from UV rays and chemical agents. They are also excellent electrical insulators.* ”

- Wireless. Installed and extended without the need for building work.
- Control via a smartphone, tablet, the cloud, from both inside and outside the home.
- **Made in Europe** according to strict quality standards and European regulations, allowing us to provide a 5-year warranty.
- Compatible with Google Nest and Alexa voice assistants.
- Control it using the free BJC Nexus app, as well as the Google Home and Amazon Alexa apps.
- Can be integrated with Home Assistant.
- Cloud located on **servers in Europe** with European cybersecurity and data protection standards.
- You can combine the modules with any model in the BJC series to get your home connected.



Combine the modules with the Iris Plus series to get your home connected.

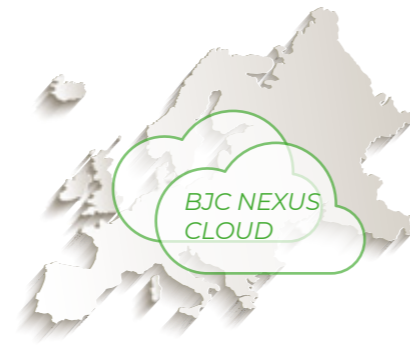

BJC Nexus Cloud located in Europe



Download the BJC Nexus app



“

The BJC Nexus system provides full, easy control of your home from your mobile device using the dedicated app, as well as through compatible voice assistants such as Alexa or Google Home.



Discover the advantages of BJC Nexus in our video



Find out more about BJC Nexus

Iris Plus

Accuracy and reliability

Socket outlets,
with the speed and safety
of the STAI system

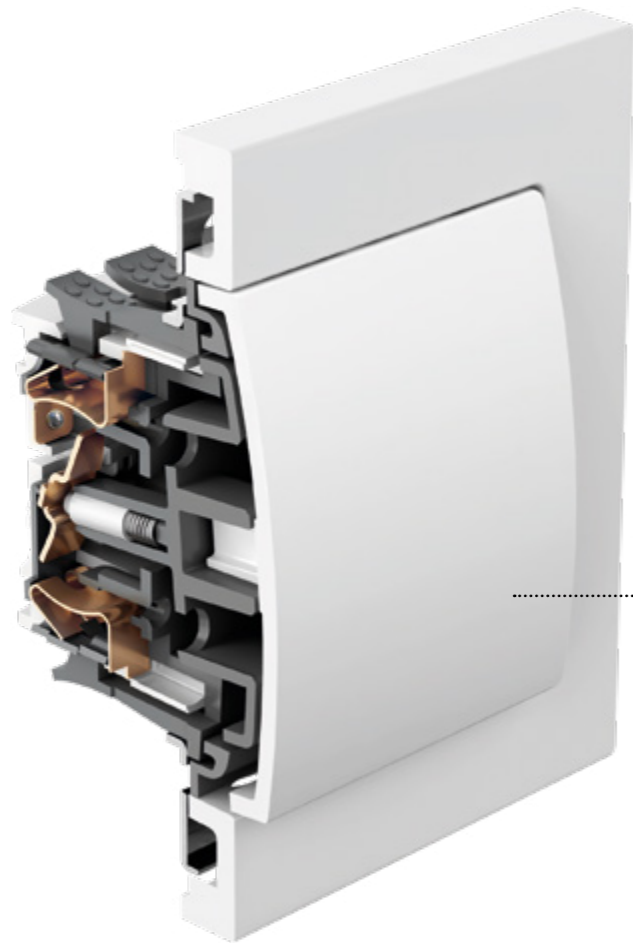
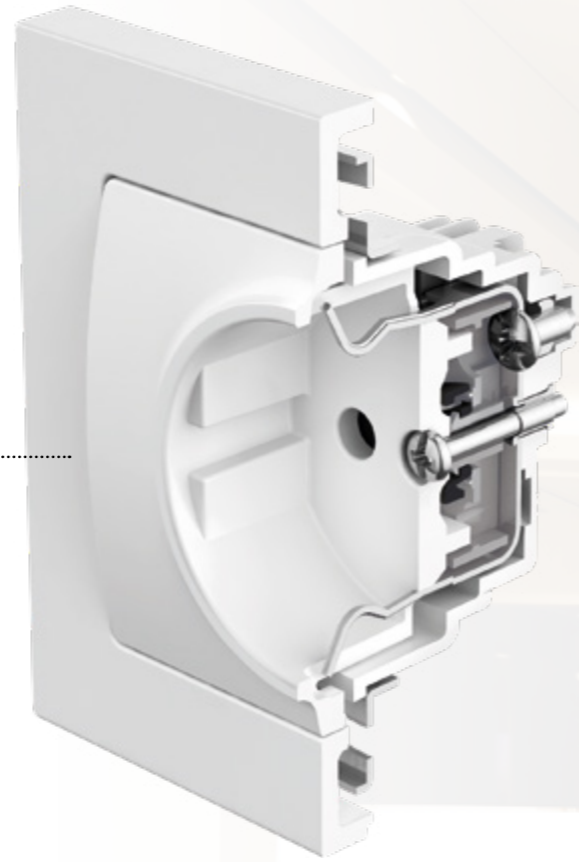

MEC 18 switches



“ The high resistance of urea to wear and tear, coupled with the fact that BJC mechanisms effortlessly meet or exceed current regulatory requirements for contact operations, ensures that BJC series products have an extended useful life.



Iris Plus

Component quality

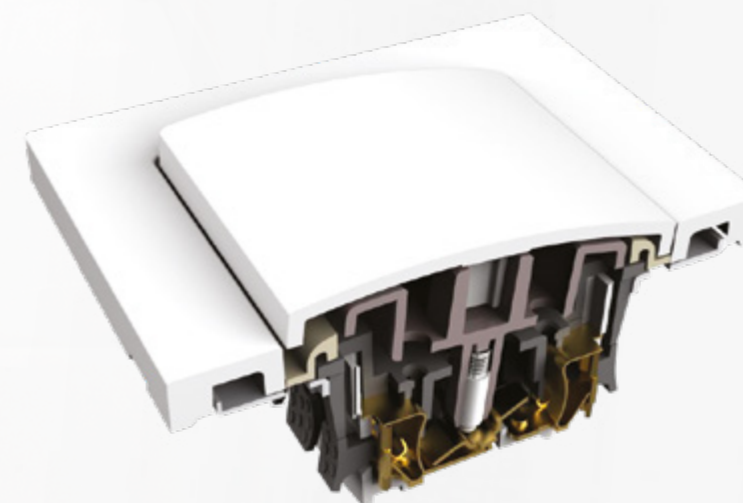

The high quality of all the components, such as the silver contacts with the highest purity, enables us to offer 16 A in each one-way switch mechanism. We can also guarantee that they will far exceed the minimum changeover requirements required by current regulations before we take them to market.

“ *The series features a flat surface frame and right angles for a sober and modern aesthetic. This design contrasts harmoniously with the soft curvature of the switch, creating a balanced and attractive visual effect.* ”

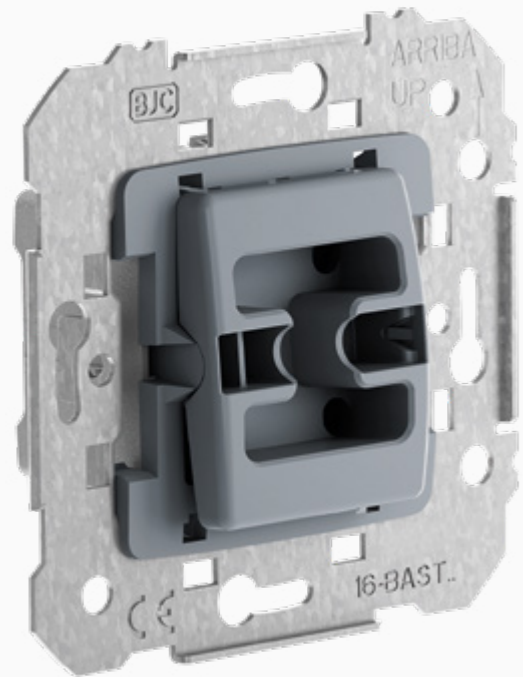

MEC 18

One single mechanism is suitable for all five luxury BJC series: Iris, Iris Plus, Mega, Style and Miro.

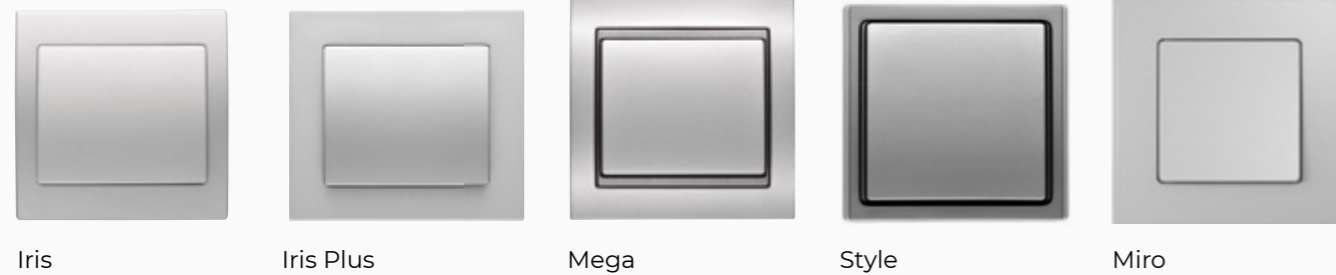

Iris

Iris Plus

Mega

Style

Miro

- ▷ Our 16A MEC18 one-way and two-way switches allow for a large number of applications using the same mechanism, reducing the number of items and references you need to stock.
- ▷ The galvanised steel fixing frames are treated to prevent corrosion and ensure durable installation components.
- ▷ Fixing frames with top and bottom profiles make assembly easier and ensure that the mechanisms in multiple frames are correctly aligned.

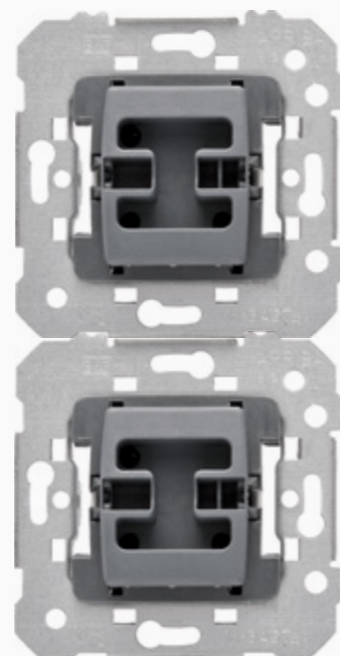

Iris Plus

Antibacterial solutions



Thanks to their antibacterial finish, Iris and Iris Plus impede the survival and transmission of microorganisms. This makes them the perfect choice for environments in which microorganisms thrive and the risk of transmission is high, such as hospitals, care homes, residential homes, care centres and communal areas in offices or homeowners' associations.

“

It impedes the survival and transmission of microorganisms



Iris Plus

Many different functions



Smart Home
Combining BJC Nexus modules to get your home connected.



1 RJ and fibre-optic sockets
This allows the fibre-optic cable to reach the required location and enables the router to be easily connected.



2 Dimmers
Dimmers are the perfect way to create an atmosphere in rooms by adjusting the lighting levels to the desired intensity.



3 IP44 protection
In all colours and frames. Same mechanism and frame as the IP20.



4 Motion detector
This practical and convenient safety solution also cuts costs.

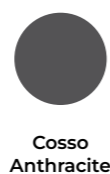
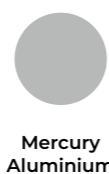
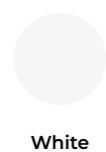

5 Centralised blind control
Allows all blinds to be raised or lowered with a single push-button, individually or together.



6 Dual USB chargers
USB Type A and C with fast charging and Power Delivery.



7 LED indicator light
They allow you to illuminate: stairs, waiting rooms, interiors, corridors and calls.



8 Multimedia
HDMI, VGA, RJ45, stereo, etc. connectors for a clean and cable-free installation. Ideal for homes and businesses.



9 Thermostats
Our thermostats can be used to control and adjust the temperature in each room.

“The Iris Plus series offers a wide range of functions to meet today's needs. These include light intensity dimmers, sound controllers, and mechanisms for raising and lowering blinds.”

Iris Plus IP44

Now also for outdoor use

- ▷ In all colours and frames.
- ▷ Schuko® socket outlet, single and double mechanism, TV and RJ.
- ▷ A single common IP20 frame from the same series.



RJ Iris Plus IP44 assembly example

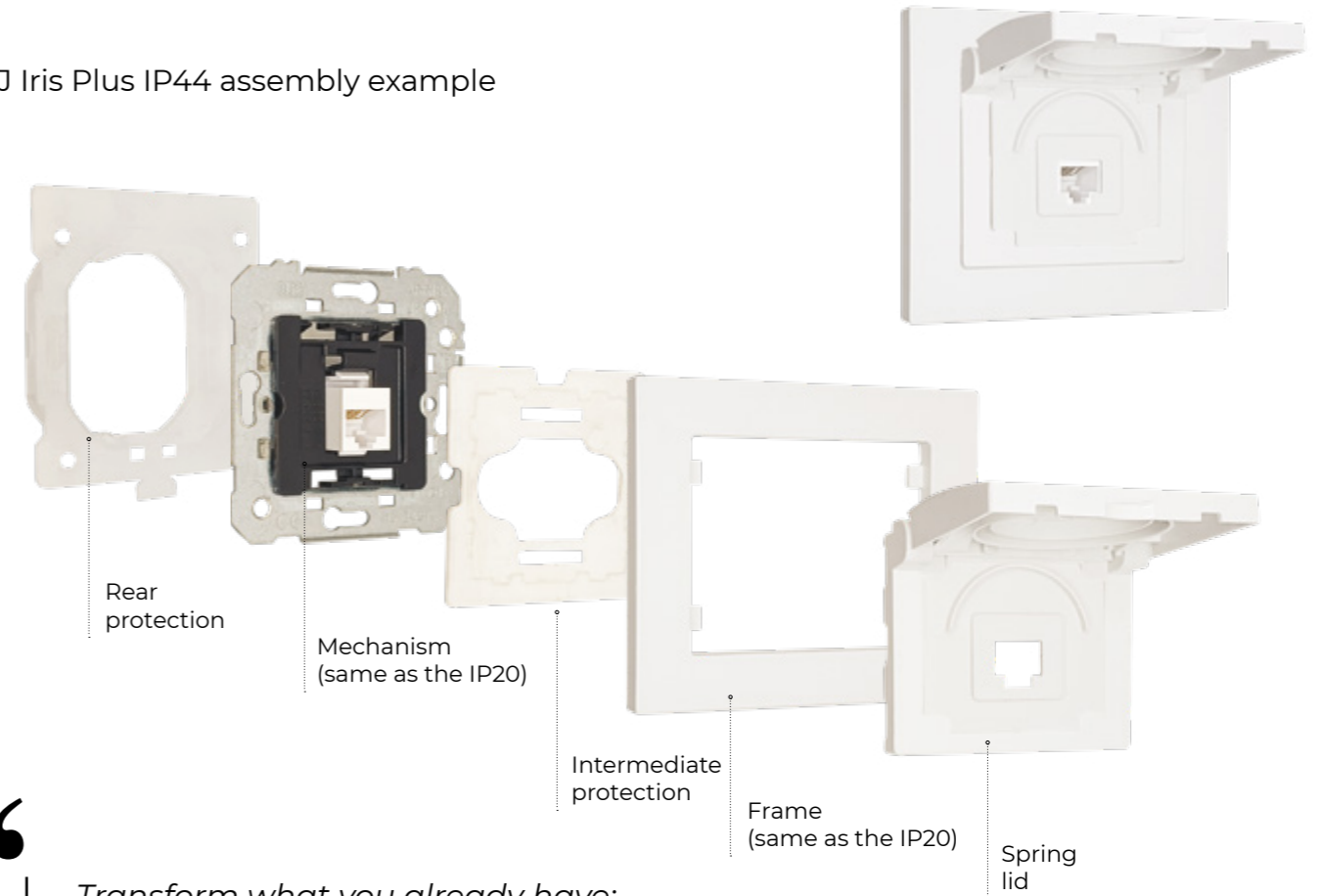

“

*Transform what you already have:
IP44 is compatible with standard
mechanisms and frames.*



Reference table for composing basic functions - Iris Plus

White
 Mercury Aluminium
 Chocolate
 Cosso Anthracite

Function	Mechanism	Switch/Cover	Switch/Cover	Frame
One-way switch	18505	18705*	22705-AC	18011*
Two-way switch	18506	18705*	22705-AC	18011*
Intermediate switch	18507	18705*	22705-AC	18011*
Double one-way switch	18509	18709*	22709-AC	18011*
Double two-way switch	18510	18709*	22709-AC	18011*
Push-button, bell symbol	18516	18716*	22716-AC	18011*
Push-button, bulb symbol	18516	18717*	22717-AC	18011*
Rotary dimmer	21550-X	18749*	22749-AC	18011*
Schuko® socket outlet	18524	18724*	22724-AC	18011*
Schuko® socket outlet + dual type A and C USB	18524-USBC	18724-USBC*	22724-USBC-AC	18011*
Television socket outlet	2932	18330*	22330-AC	18011*
Single RJ socket outlet	19582-1	19782*	22782-AC	18011*
Double RJ socket outlet	19682-1	19882*	22783-AC	18011*
Blank cover	---	18033*	22033-AC	18011*
Cable output	18534	18734*	22734-AC	18011*
Buzzer	18536-B	18730*	22730-AC	18011*
Key card switch	---	18068*	22068-AC	18011*
IP44 one-way switch	18505	18705-IP*	22705-IP-AC	18011*
IP44 two-way switch	18506	18705-IP*	22705-IP-AC	18011*
IP44 intermediate switch	18507	18705-IP*	22705-IP-AC	18011*
IP44 double one-way switch	18509	18709-IP*	22709-IP-AC	18011*
IP44 double two-way switch	18510	18709-IP*	22709-IP-AC	18011*
IP44 push-button, bell symbol	18516	18716-IP*	22716-IP-AC	18011*
IP44 push-button, bulb symbol	18516	18717-IP*	22717-IP-AC	18011*
Schuko® IP44 socket outlet	18524	18725-IP*	22725-IP-AC	18011*
IP44 television socket outlet	2932	18330-IP*	22330-IP-AC	18011*
IP44 single RJ socket outlet	19582-1	19782-IP*	22782-IP-AC	18011*

* For remaining colours, add the extension colour:

Colour			
	White	-	
	Mercury Aluminium	-MA	
	Chocolate	-CH	
	Cosso Anthracite	-AC	





[Visit our website](#)

BJC

Fábrica Electrotécnica Josa, SAU
Av. de la Llana, 95
08191 Rubí (Barcelona)
España / Spain

Customer Service
935 610 526
sac@bjc.es

Technical Support
900 67 00 68
sat@bjc.es

Sales Administration
900 67 00 77
ventas@bjc.es

www.bjc.es

